

L.U.PLAST



CATALOGO
PRODUZIONE ACCESSORI
IN PLASTICA

PUNTALI ALETTATI IN POLITENE

neri - bianchi (colorati a richiesta) - Misure riferite al Ø esterno del tubo

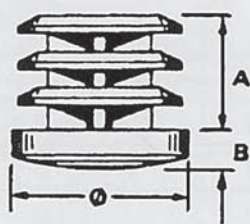

CODICE	Ø TESTA	A	B
A010	10	13	5
A011	12	14	5
A012	14	14	5
A013	16	16	5
A014	18	13	5
A015	20	13	5
A016	22	13	5
A017	24	20	5
A018	25	19	5
A019	26	20	5
A020	28	19	5
A021	30	19	5
A022	32	19	5
A023	35	20	5
A024	38	22	5
A025	40	22	5
A026	42	22	5
A027	45	30	5
A028	50	22	5
A029	55	22	5
A030	60	24	5
A031	80	33	5

PUNTALI ALETTATI IN POLITENE A BASE ALTA

neri - bianchi (colorati a richiesta) - Misure riferite al Ø esterno del tubo

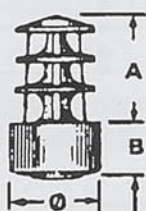

CODICE	Ø TESTA	A	B
A050	15	17	9
A051	16	17	9
A052	18	17	9
A053	22	17	11

PUNTALI

PUNTALI ROTONDI ALETTATI E FILETTATI IN TECNOPOLIMERO

neri - bianchi (colorati a richiesta)

Filetto 10 MA - A richiesta filetto 8 MA - Misure riferite al \varnothing esterno del tubo

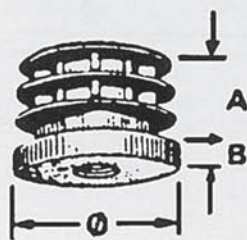

CODICE	Ø TESTA	A	B
A100	18	18	6
A101	20	18	6
A102	22	19	6
A103	25	19	6
A104	28	19	6
A110	28x2	19	6
A105	30	19	6
A106	32	19	6
A107	35	20	6
A108	40	21	6
A111	45	21	6
A109	50	21	6

PUNTALI CON GHIERA

neri - bianchi (colorati a richiesta)

Le misure con asterisco sono alettate e in politene quelle lisce sono in PVC

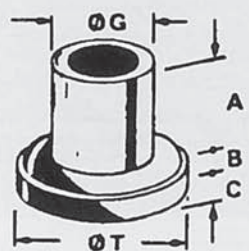
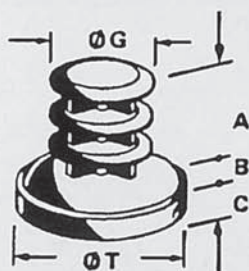

CODICE	Ø GAMBO X TESTA	A	B	C
A200	8x18	16	3	5
A201	7-8x18	17	3	5
A202	10x20	17	3	5
A203	12x24	17	4	5
A204	14x28	17	4	5
A205	15-16x26	17	4	5
A206	17x32	17	4	5
A207	18x32	17	4	6
A208	19-20x34	17	4	5
A209	22x36	17	4	6
A220	22-23x36	17	4	6

PUNTALI COPRITESTA, A TESTA SFERICA ALETTATI

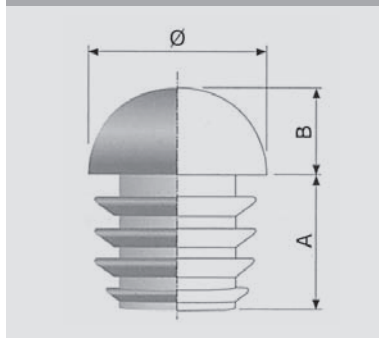

neri (colorati a richiesta)

CODICE	Ø TESTA	A	B
A279	16	12	7
A280	18	12	7,5
A281	20	15	9
A282	22	15	10
A283	25	15	11
A284	28	16	12,5
A287	35	20	17
A288	38	22	18

PUNTALI ROTONDI PER TUBO ESTERNO - EXPORT IN PVC

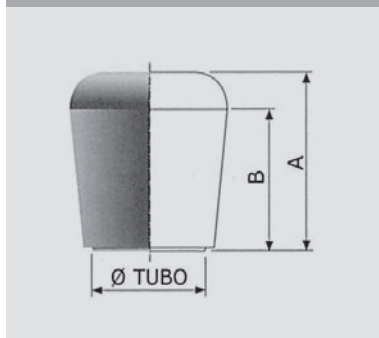

neri - bianchi (colorati a richiesta)
Misure riferite all'esterno del tubo

CODICE	Ø TUBO	A	B
B273	2	7,5	6
B271	3	9,5	8
B270	4	11	9
B265	5	13	10
B266	6	14	11
* B250	7	14	11
B264	8	16	13
* B251	9	17	13
B252	10	18	14
B253	12	21	17
* B254	13	21	17
B267	14	23	18
B255	16	25	20
B256	18	27	22
* B257	19	28	23
B258	20	30	24
B259	22	32	26
B260	24-25	36	30
B263	26	37	31
B261	28	38	32
B268	30	41	34
B262	32	43	39
B269	35	47	40

* Misure speciali

PUNTALI

PUNTALI QUADRI ALETTATI IN POLITENE

neri - bianchi (colorati a richiesta) - Misure riferite all'esterno del tubo

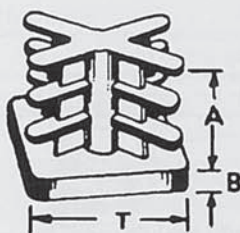

CODICE	TESTA	A	B
A550	12 x 12	12	5
A551	15 x 15	11	4
A552	16 x 16	17	5
A553	18 x 18	12	5
A554	20 x 20	17	5
A555	22 x 22	17	5
A556	25 x 25	20	6
A557	30 x 30	21	6
A558	35 x 35	21	6
A559	40 x 40	21	6
A561	45 x 45	21	6
A560	50 x 50	21	6
A562	60 x 60	22	6
A563	70 x 70	25	6

PUNTALI QUADRI ALETTATI INCLINATI 30° IN POLITENE

neri - bianchi (colorati a richiesta) - Misure riferite all'esterno del tubo



CODICE	TESTA	A	B
A600	20 x 20	19	6
A601	25 x 25	18	6
A602	30 x 30	20	6

PUNTALI QUADRATI FILETTATI E ALETTATI IN TECNOPOLIMERO

neri - bianchi (colorati a richiesta) - Filetto 10MA - A richiesta filetto 8MA
Misure riferite all'esterno del tubo - *Da non usare per le rotelle*



CODICE	Ø TESTA	A	B
A700	15 x 15	18	5
A701	16 x 16	18	5
A702	18 x 18	18	5
A703	20 x 20	18	5
A704	22 x 22	18	5
A705	25 x 25	19	5
A706	30 x 30	20	6
A707	35 x 35	21	6
A708	40 x 40	22	6
A709	50 x 50	30	6

PUNTALI RETTANGOLARI ALETTATI IN POLITENE

neri - bianchi (colorati a richiesta) - Misure riferite all'esterno del tubo



CODICE	Ø TESTA	A	B
A771	10 x 15	11	5
A750	10 x 20	15	5
A751	10 x 25	15	5
A752	10 x 30	15	5
A753	10 x 40	15	5
A754	15 x 20	12	5
A755	15 x 25	17	5
A756	15 x 30	12	5
A757	15 x 35	18	6
A758	15 x 40	18	6
A773	15 x 50	15	5
A769	20 x 25	12	5
A759	20 x 30	17	5
A760	20 x 35	17	5
A761	20 x 40	17	5
A762	20 x 50	17	6
A763	20 x 60	17	6
A764	25 x 35	19	6
A765	25 x 40	18	5
A766	25 x 50	21	6
A770	30 x 40	18	5
A767	30 x 50	18	6
A768	30 x 60	18	6
A772	40 x 80	21	6
A774	27 x 40	18	5
A775	60 x 40		

PUNTALI RETTANGOLARI ALETTATI INCLINATI 30° IN POLITENE

neri - bianchi (colorati a richiesta) - Misure riferite all'esterno del tubo



CODICE	TESTA	A	B
A800	15 x 30	18	6
A801	20 x 40	19	6

PUNTALI

PUNTALI RETTANGOLARI ALETTATI INCLINATI 20° IN POLITENE

neri - bianchi (colorati a richiesta) - Misure riferite all'esterno del tubo

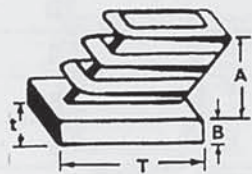

CODICE	Ø TESTA	A	B
A825	20 x 30	18	6

PUNTALI RETT. INCLIN. 30° ALETTATI A ZOCCOLO IN POLITENE

neri - bianchi (colorati a richiesta) - Misure riferite all'esterno del tubo

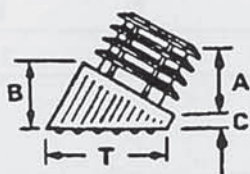

CODICE	Ø TESTA	A	B	C
A830	15 x 30	22	22	5

PUNTALI RETTANG. ALETTATI E FILETTATI IN TECNOPOLIMERO

neri - bianchi (colorati a richiesta) - Filetto 10MA: a richiesta filetto 8MA
Misure riferite all'esterno del tubo - *Da non usare per le rotelle*

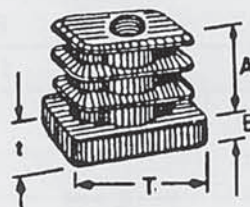

CODICE	Ø TESTA	A	B
A852	20 x 30	19	6
A853	20 x 35	19	6
A854	20 x 40	19	6
A855	20 x 50	19	6
A856	20 x 60	19	6
A857	50 x 25	22	6
A851	15 x 30		

PUNTALI A ELISSE ALETTATO IN POLITENE

neri - bianchi (colorati a richiesta) - Misure riferite all'esterno del tubo

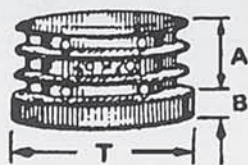

CODICE	Ø TESTA	A	B
A400	20 x 40	18	6

PUNTALI OVALI ALETTATI IN POLITENE

neri - bianchi (colorati a richiesta) - Misure riferite all'esterno del tubo

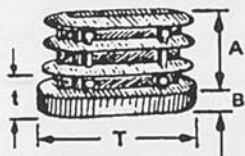

CODICE	Ø TESTA	A	B
A420	15 x 30	18	5
A421	18 x 36	18	6
A422	20 x 40	19	6

PUNTALI OVALI INCLINATI 12,5° IN POLITENE

neri - bianchi (colorati a richiesta) - Misure riferite all'esterno del tubo

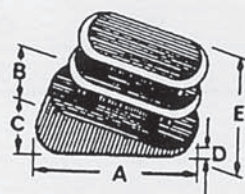

CODICE	A	B	C	D	E
A610	30	15	9,5	3,5	11

PUNTALI OVALI INCLINATI ALLA BASE 20° E GAMBE 30°

neri - bianchi (colorati a richiesta) - Misure riferite all'esterno del tubo

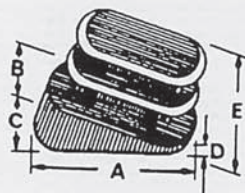

CODICE	A	B	C	D	E
A611	30	15	9,5	4	11

PUNTALI OVALI ALETTATI FILETTATI IN TECNOPOLIMERO

neri - bianchi (colorati a richiesta) - Filetto 10MA: a richiesta filetto 8MA
Misure riferite all'esterno del tubo - *Da non usare per le rotelle*

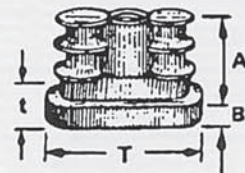

CODICE	Ø TESTA	A	B
A450	18 x 36	18	6,5
A451	20 x 36	18	6,5

PUNTALI PER INTERNO

PUNTALI A CAMPANA IN PVC

neri - bianchi (colorati a richiesta) - A base larga - Misure riferite all'esterno del tubo

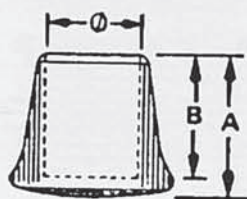

CODICE	Ø TUBO	A	B
B350	6	20	16
B351	8	23	18
B352	10	25	21
B353	12	27	23
B354	14	28	22
B355	16	29	22
B356	18	31	24
B357	20	33	26
B358	22	35	27
B359	24	35	28
B360	26	37	32
B361	28	41	34
B362	30	44	36

PUNTALI BOMBATI LUNGI IN PVC

neri - bianchi (colorati a richiesta) - Misure riferite all'esterno del tubo

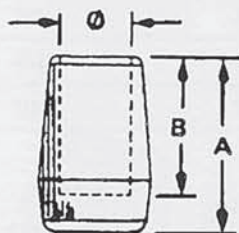

CODICE	Ø TUBO	A	B
B450	10	28	22
B451	12	31	24
B452	14	34	27
B453	16	36	29
B454	18	38	31
B455	20	40	33

PUNTALI A BOTTE IN PVC

neri - bianchi (colorati a richiesta) - Misure riferite all'esterno del tubo

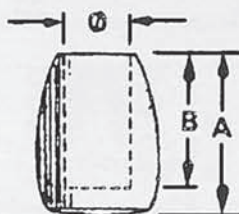

CODICE	Ø TUBO	A	B
B400	6	19	14
B401	8	21	16
B402	10	23	18
B403	12	26	20
B404	14	28	21
B405	16	30	23
B406	18	31	24

PUNTALI PER SCAFFALATURE

PUNTALI PER ANGOLARI IN POLITENE

neri (colorati a richiesta) - Spessore mm. 1,5

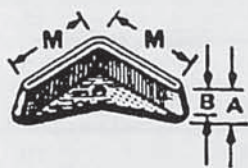

CODICE	MISURA	A	B
C009	27 x 27	11,5	9,5

Spessore mm. 2

CODICE	MISURA	A	B
C010	30 x 30	12,5	10
C011	35 x 35	12,5	10
C012	40 x 40	13,0	10

PUNTALI PER DOPPIO ANGOLARE IN POLITENE

neri (colorati a richiesta) - Spessore mm. 2

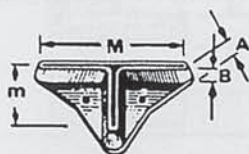

CODICE	Ø TESTA	A	B
C050	70 x 35	12,5	10

PUNTALI PER ANGOLARI A L IN POLITENE

neri (colorati a richiesta) - Spessore mm. 2 - Destri

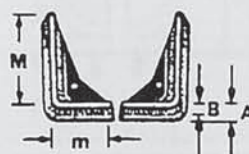

CODICE	MISURA	A	B
C100	35 x 55	12,5	9,5
C101	20 x 40	13,0	10

Sinistri

CODICE	MISURA	A	B
C102	35 x 55	12,5	9,5
C103	20 x 40	13,0	10

PUNTALI ANGOLARI A U IN PVC

neri (colorati a richiesta) - Spessore mm. 2

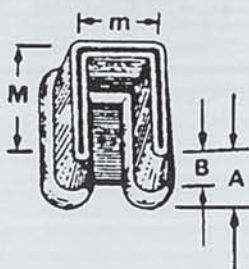

CODICE	MISURA	A	B
C150	30 x 30 x 35	25	18

PUNTALI PER SCAFFALATURE

PUNTALI ANGOLARI IN POLITENE

neri (colorati a richiesta) - Adatto ad essere infilati negli appoggi ad angolo

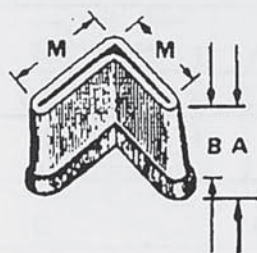

CODICE	MISURA	A	B
C200	20 x 20	20	15
C201	25 x 25	24	19
C202	30 x 30	24	19
C203	35 x 35	24	19

PUNTALI ANGOLARI BASE DIRITTA IN POLITENE

neri (colorati a richiesta)

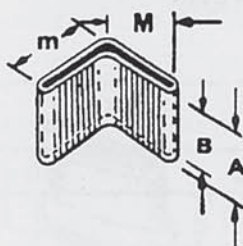

CODICE	MISURA	A	B
C250	25 x 25	25	

PUNTALI ESTERNO PER PIATTO PVC

neri (colorati a richiesta)

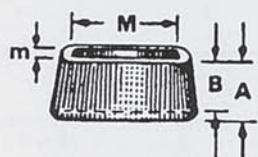

CODICE	MISURA	A	B
C300	25 x 8	19	15
C304	25 x 5	19	15
C301	25 x 6	19	15
C302	30 x 6	19	15
C303	25 x 3		

PUNTALI COPRITESTA SEMI OVALI IN POLITENE

neri - bianchi (colorati a richiesta) - Misure riferite all'esterno del tubo

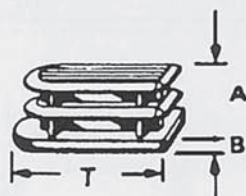

CODICE	MISURA	A	B
A590	15 x 30	12	3,0
A591	20 x 40	13	3,5
A592	25 x 40	13	3,5

COPRITESTA O PUNTALI OVALI TESTA ALTA

neri - bianchi (colorati a richiesta) - Misure riferite all'esterno del tubo



CODICE	A	B	C	D
A310	30	15	8	12

COPRITESTA ALETTATO IN POLITENE

neri - bianchi (colorati a richiesta) - Misure riferite all'esterno del tubo

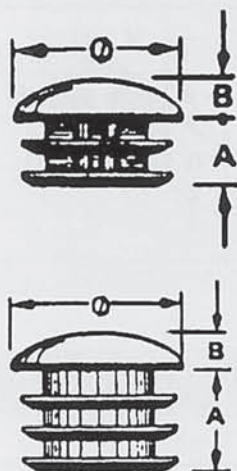

CODICE	Ø TESTA	A	B
D150	10	8	2
D151	12	8	2
D152	14	8	2
D153	15	8	3
D154	16	8	3
D155	18	9	3
D156	20	13	4
D205	22	10	4
D025	25	13	4
D207	28	15	5
D208	30	15	5
D209	32	16	5
D210	35	17	5
D211	40	17	5
D212	45	17	5
D213	50	17	5
D214	60	17	5
D215	80	17	6

COPRITESTA A SFERA IN PVC - COLORATI (R)

neri (colorati a richiesta) - Adatte per terminali fili ferro

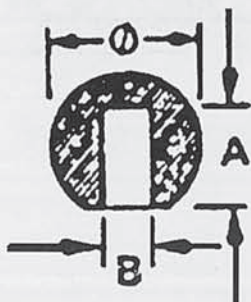

CODICE	SFERA Ø	A	B
D350	MM. 10	7	3
D351	MM. 10	8	4
D352	MM. 14	12	5

COPRITESTA

COPRITESTA IN PLASTICA ALETTATO CON TESTA IN METALLO

cromati - ottonati - Misure riferite all'esterno del tubo

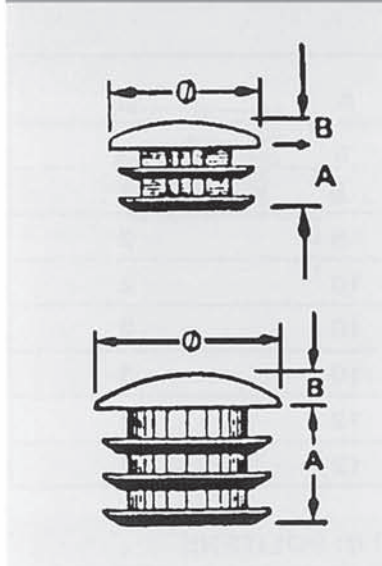

CODICE	Ø TESTA	A	B
D263	13	8	2
D250	14	10	2
D251	16	10	2
D252	18	10	2
D264	19	10	2
D253	20	10	3
D254	22	11	3
D256	25	15	3
D266	25,0 x 1,5	15	3
D267	25,0 x 1,8	15	3
D265	25,0 x 2,0	15	3
D269	25,5 x 1,5	15	3
D258	28	15	3
D270	28,6	15	3
D259	30	16	3
D260	32	16	3
D261	35	16	3
D255	38	16	3
D262	40	16	3
D257	45	16	3

COPRITESTA QUADRI IN POLITENE

neri - bianchi - Misure riferite all'esterno del tubo

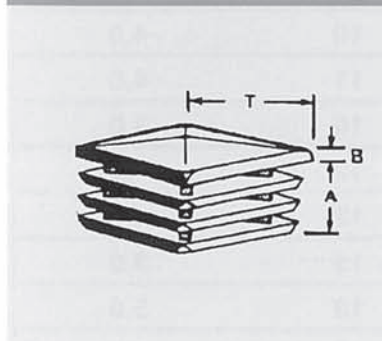

CODICE	Ø TESTA	A	B
D750	12 x 12	9	3
D751	14 x 14	10	3
D759	15 x 15	11	3
D752	16 x 16	10	3
D753	18 x 18	10	3
D754	20 x 20	11	4
D755	25 x 25	15	5
D756	30 x 30	15	5
D757	35 x 35	15	4
D758	40 x 40	15	4

COPRITESTA IN PLASTICA CON TESTA IN METALLO

cromati - ottonati - Misure riferite all'esterno del tubo

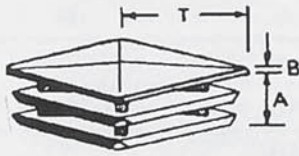

CODICE	Ø TESTA	A	B
D800	15 x 15	-	-
D801	16 x 16	9	2
D802	18 x 18	9	2
D803	20 x 20	10	2
D804	25 x 25	10	2
D805	30 x 30	10	3
D806	35 x 35	12	3
D807	40 x 40	12	3

COPRITESTA RETTANGOLARI ALETTATI IN POLITENE

neri - bianchi (colorati a richiesta) - Misure riferite all'esterno del tubo

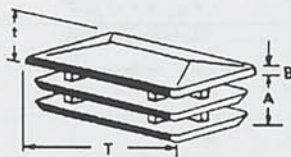

CODICE	Ø TESTA	A	B
D865	10 x 15	9	3,0
D850	10 x 20	9	3,0
D851	10 x 30	9	3,0
D852	10 x 40	9	3,0
D853	15 x 20	10	3,5
D863	15 x 25	10	3,5
D854	15 x 30	10	3,5
D855	15 x 35	10	3,5
D856	15 x 40	10	3,5
D857	20 x 30	10	4,0
D858	20 x 35	10	4,0
D859	20 x 40	11	4,0
D864	20 x 80	16	3,0
D860	25 x 40	12	4,0
D861	25 x 50	12	4,0
D866	25 x 100	15	3,0
D868	30 x 40	13	5,0
D862	30 x 50	13	5,0
D867	30 x 100	16	3,0

COPRITESTA

COPRITESTA IN PLASTICA RIGIDA CON TESTA IN METALLO CROMATO

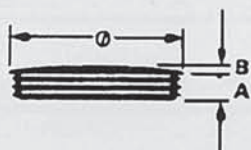

CODICE	Ø T.	S.T.	A	B
D300	50	1	12	3
D301	50	1,2	12	3
D302	50	1,5	12	3
D303	50	2	12	3
D304	60	1	12	3
D305	60	1,2	12	3
D306	60	1,5	12	3
D307	60	2	12	3
D312	80	1	-	-
D313	80	1,2	12	3
D314	80	1,5	12	3
D315	80	2	-	-

COPRITESTA TUBI IN FERRO IMBUTITO

Adatti per turare le estremità dei tubi

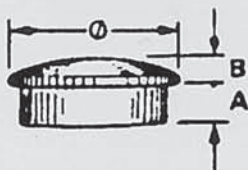

CODICE	Ø T.	S.T.	A	B
D451	16	1,5	7	2
D452	18	1,5	7	2
D453	18	1,2	7	2
D454	18	1	7	2
D455	20	1,2	10	2
D456	20	1	10	2
D457	22	1,5	9	3
D458	22	1,2	9	3
D459	25	1,5	9	3
D460	25	1,2	9	3
D461	28	1,5	7	3
D472	30	2	8	3
D462	30	1,5	8	3
D463	30	0,85	8	3
D471	32	2	8	3
D464	32	1,5	8	3
D465	32	1,2	8	3
D466	32	1	8	3
D467	35	1,5	9	3
D468	35	1,2	9	3
D469	35	1	9	3
D470	40	1	9	4
D474	40	1,5	9	4

COPRITESTA IN PLASTICA OVALE CON TESTA IN METALLO CROMATO

Misure riferite all'esterno del tubo

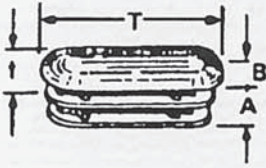

CODICE	Ø TESTA	A	B
D134	10 x 20	10	2
D135	15 x 30	10	2,5
D137	18 x 36	11	3
D136	20 x 40	10	3

COPRITESTA IN PLASTICA RETTANGOLARE CON TESTA IN METALLO CROMATO

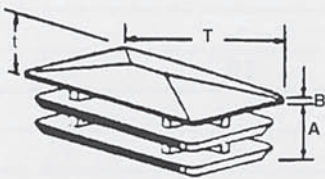

CODICE	Ø TESTA	A	B
D841	10 x 20	10	1.5
D842	15 x 20	10	2.0
D843	15 x 30	10	2.0
D840	20 x 40	11	2.0

COPRITESTA OVALI ALETTATI IN POLITENE

neri - bianchi (colorati a richiesta) - Misure riferite all'esterno del tubo



CODICE	Ø TESTA	A	B
D050	10 x 20	10	2
D051	15 x 30	10	3
D052	18 x 36	10	3
D053	20 x 40	10	4
D054	60 x 30	10	4

COPRITESTA TESTA SFERICA

Metallizzata argento-oro

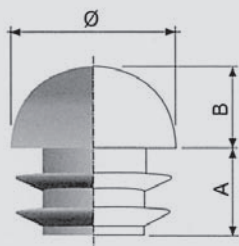

CODICE	Ø TESTA	A	B
d415	25	13	14

COPRITESTA ROTONDI IN ABS

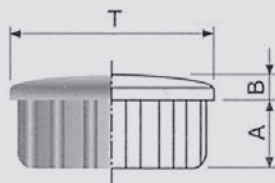

neri - metallizzati argento - oro - verniciato alluminio
(altri colori a richiesta)

CODICE	Ø T	S.T.	A	B
D561	8	1	4,5	1,5
D563	10	1	5	2
D565	12	1	5	2
D579	13	1	6	2
D567	14	1	8	2
D570	16	1	8	3
D571	16	1,2	8	3
D572	16	1,5	8	3
D573	18	1	8	3
D574	18	1,2	8	3
D575	18	1,5	8	3
D578	19	1,2	9	3
D500	19	1,5	9	3
D502	20	1	8	3
D503	20	1,2	8	3
D504	20	1,5	8	3
D506	22	1	8	3
D507	22	1,2	8	3
D508	22	1,5	8	3
D509	22	2	8	3
D510	25	1	11	4
D511	25	1,2	11	4
D512	25	1,5	11	4
D513	25	2	11	4
D580	25,4	1,25	11	4
D581	26	1	13	4
D514	28	1	10	4
D515	28	1,2	10	4
D516	28	1,5	10	4
D517	28	2	10	4
D518	30	1	10	5
D519	30	1,2	10	5
D520	30	1,5	10	5
D521	30	2	10	5
D523	32	1,2	10	4
D524	32	1,5	10	4
D525	32	2	10	4
D586	32	3	10	4
D526	35	1	10	3
D527	35	1,2	10	3
D528	35	1,5	10	3
D529	35	2	10	3
D532	38	1,5	10	3
D533	38	2	10	3
D534	40	1	10	3
D536	40	1,5	10	3
D537	40	2	10	3
D559	45	1,5	11	4
D560	45	2	11	4
D538	50	1	11	5
D539	50	1,2	11	5
D540	50	1,5	11	5
D541	50	2	11	5
D542	60	1	11	5
D543	60	1,2	11	5
D544	60	1,5	11	5
D547	70	1,2	11	5
D548	70	1,5	11	5
D551	80	1,2	11	5
D552	80	1,5	11	5
D555	90	1,2	11	5
D556	90	1,5	11	5
D499	120	5	16	8

COPRITESTA QUADRI IN ABS

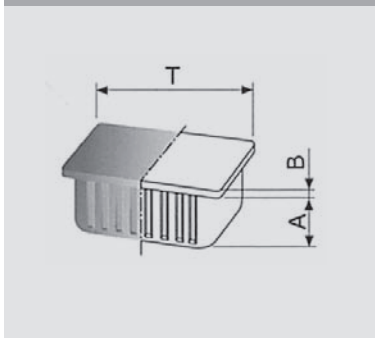

neri - metallizzati argento - oro - verniciati alluminio
(altri colori a richiesta)

CODICE	T	S.T.	A	B
D650	12 x 12	1	7	2
D651	12 x 12	1,2	7	2
D654	15 x 15	1	8,5	2,5
D655	15 x 15	1,2	8,5	2,5
D656	15 x 15	1,5	8,5	2,5
D660	16 x 16	1,5	8	3
D663	18 x 18	1,2	8	3
D664	18 x 18	1,5	8	3
D666	20 x 20	1,2	7	3
D667	20 x 20	1,2	7	3
D668	20 x 20	1,5	7	3
D670	25 x 25	1	7	3
D672	25 x 25	1,5	7	4
D673	25 x 25	2	7	4
D674	30 x 30	1	10	4
D675	30 x 30	1,2	10	4
D676	30 x 30	1,5	10	4
D679	35 x 35	1,2	11	4
D680	35 x 35	1,5	11	4
D683	40 x 40	1,2	11	4
D684	40 x 40	1,5	11	4
D716	45 x 45	1,2	11	5
D717	45 x 45	1,5	11	4
D687	50 x 50	1,2	11	5
D688	50 x 50	1,5	11	5
D691	60 x 60	1,2	12	5
D692	60 x 60	1,5	12	5
D695	80 x 80	1,2	12	5
D696	80 x 80	1,5	12	5
D697	80 x 80	2	12	5

COPRITESTA RETANGOLARI IN ABS

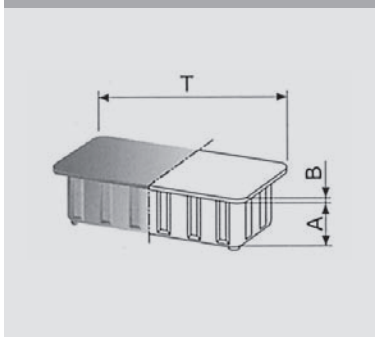

neri - metallizzati argento - oro - verniciati alluminio
(altri colori a richiesta)

CODICE	T	S.T.	A	B
D940	8 x 15	1	8	2
D900	10 x 15	1	9	2
D901	10 x 15	1,2	9	2,5
D903	10 x 20	1	9	2,5
D904	10 x 20	1,2	9	2,5
D908	10 x 25	1,5	9	2,5
D911	10 x 30	1,5	9	2,5
D913	10 x 40	1,2	8	3
D914	10 x 40	1,5	8	3
D916	15 x 20	1,2	8	3
D917	15 x 20	1,5	8	3
D920	15 x 25	1,5	9	3
D922	15 x 30	1,2	9	3
D923	15 x 30	1,5	9	3
D926	15 x 35	1,5	9	3
D927	15 x 40	1	9	3
D928	15 x 40	1,2	9	3
D929	15 x 40	1,5	9	3
D931	20 x 30	1,2	9	3
D932	20 x 30	1,5	9	3
D935	20 x 35	1,5	9	3
D937	20 x 40	1,2	9	3,5
D938	20 x 40	1,5	9	3,5
D942	20 x 50	1,2	10	3
D943	20 x 50	1,5	10	3
D939	20 x 60	1,5	10	3

COPRITESTA OVALI IN ABS

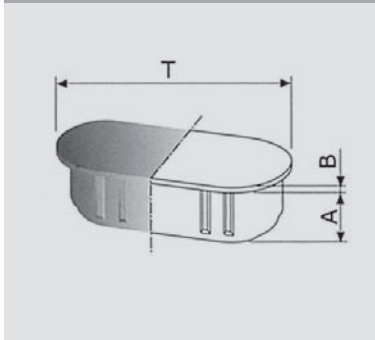

neri - metallizzati argento - oro - verniciati alluminio
(altri colori a richiesta)

CODICE	Ø T	S.T.	A	B
D100	10 x 20	1	9	2,5
D101	10 x 20	1,2	9	2,5
D105	10 x 20	1,5	9	3
D108	15 x 25	1,5	9	3
D110	15 x 30	1,2	10	3
D111	15 x 30	1,5	10	3
D113	20 x 30	1,2	10	3
D114	20 x 30	1,5	10	3
D117	20 x 35	1,5	10	3
D120	20 x 40	1,5	10	3
D123	17 x 45	1,5	10	3

PIEDI REGOLABILI CON BASE IN POLITENE NERO E GAMBE IN FERRO ZINCOCROMATO

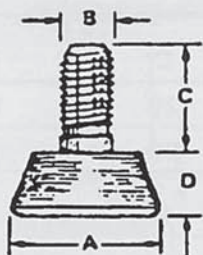

CODICE	A	B	C	D
R150	Ø 30	Ø 8	20	
R151	Ø 40	Ø 8	25	
R152	Ø 30	Ø 10	20	
R153	Ø 40	Ø 10	35	
R154	Ø 50	Ø 10	35	
R155	Ø 50	Ø 12	35	
R157	Ø 35	Ø 10		
R156NE	Ø 50	Ø 10	32	

REGOLABILI CILINDRI CON BASE IN POLITENE NERO E GAMBE IN FERRO ZINCOCROMATO

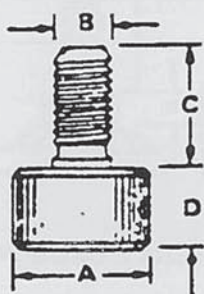

CODICE	A	B	C	D
R140	Ø 23	Ø 8	20	12
R141	Ø 23	Ø 10	20	12

PIEDE REGOLABILE STAMPATO IN PLASTICA CON ESAGONO CH. 11

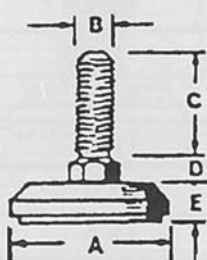

CODICE	A	B	C	D	E
R130	Ø 30	10	20	5	10

PIEDE REGOLABILE CON ESAGONO MM. 10 E VITE GIREVOLE

Neri - Cromati - Con base in nylon nera, ghiera cromata e gambo zincocromato

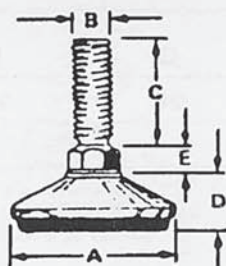

CODICE	A	B	C	D	E
R230	Ø 40	Ø 10	25	11,5	6
R230	Ø 40	Ø 10	25	11,5	6
R231	Ø 50	Ø 10	30	13,0	6
R231	Ø 50	Ø 10	30	13,0	6
R232	Ø 50	Ø 12	35	13,0	6
R232	Ø 50	Ø 12	35	13,0	6

PIEDINI

PIEDE REGOLABILE PIATTO

neri - Si producono con base in nailon nera e gambo ferro zincocromato

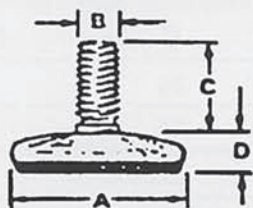

CODICE	A	B	C	D
R220	Ø 40	Ø 8	20	10
R221	Ø 40	Ø 10	20	10

PIEDE PIATTO - ATTACCO SAGOMATO Ø 11 - DIRITTO Ø 10

Si producono con base in nailon e gambo zincocromato

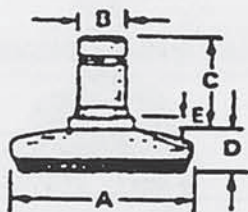

CODICE	A	B	C	D	E
R223	Ø 40	Ø 11	22	10	3,5
	Ø 40	Ø 10	22	10	3,5

REGOLABILI CON PIATTO IN ACCIAIO CON BASE GHIERA E GAMBO CROMATI

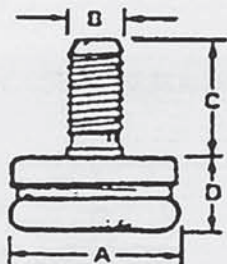

CODICE	A	B	C	D
R215	Ø 30	Ø 8	25	16
R216	Ø 30	Ø 10	25	16

PIEDI REGOLABILI CON VITE GIREVOLE E TESTA ESAGONALE MM. 17 ZINCOCROMATA

Neri - Cromati - Si producono con base in naylon e ghiera cromata

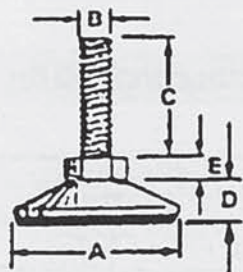

CODICE	A	B	C	D	E
R253	Ø 40	Ø 10	40	11,5	6,5
R253	Ø 40	Ø 10	40	11,5	6,5
R254	Ø 40	Ø 10	60	11,5	6,5
R254	Ø 40	Ø 10	60	11,5	6,5
R255	Ø 50	Ø 10	40	13,0	6,5
R255	Ø 50	Ø 10	40	13,0	6,5
R256	Ø 50	Ø 10	60	13,0	6,5
R256	Ø 50	Ø 10	60	13,0	6,5

PIEDE REGOLABILE IN POLITENE NERO CON BASE ZIGRINATA, GAMBO ZINCOCROMATO

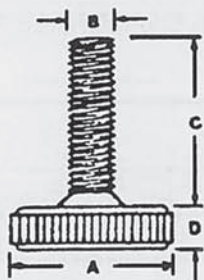

CODICE	A	B	C	D
R189	Ø 25	Ø 6	17	7
R190	Ø 25	Ø 8	25	7
R191	Ø 25	Ø 10	35	7
R192	Ø 35	Ø 8	25	9
R193	Ø 35	Ø 10	25	9
R194	Ø 35	Ø 10	30	9
R195	Ø 35	Ø 10	35	9
R196	Ø 35	Ø 10	40	9

PIEDE REGOLABILE IN POLITENE NERO CON BASE ESAGONALE E GAMBO ZINCOCROMATO

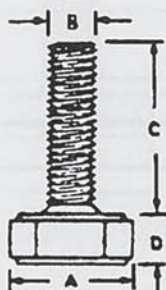

CODICE	A	B	C	D
R843	25	Ø 8	25	8
R844	25	Ø 10	25	8
R845	25	Ø 8	35	8
R846	25	Ø 10	35	8

REGOLABILI IN ACCIAIO CON BASE IN PLASTICA CON GAMBI ZINCOCROMATI O OTTONATI CON FILETTO MA

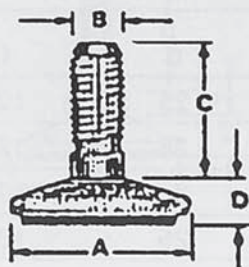

CODICE	A	B	C	D
R160	Ø 20	Ø 6	13	7
R161	Ø 25	Ø 8	20	10
R162	Ø 30	Ø 8	20	11,5
R163	Ø 35	Ø 8	20	12
R164	Ø 40	Ø 8	25	13,5
R165	Ø 25	Ø 10	20	10
R166	Ø 30	Ø 10	20	11,5
R167	Ø 35	Ø 10	20	13,5
R168	Ø 40	Ø 10	25	13,5
R169	Ø 50	Ø 10	30	15,5
R170	Ø 50	Ø 12	35	15,5

PIEDINI

PIEDINO REGOLABILE ZIGRINATO IN POLITENE

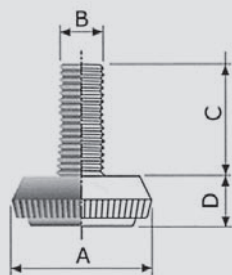

neri (colorati a richiesta)

CODICE	A	B	C	D
R820	30	8 M.A.	22.5	10
R821	30	10 M.A.	22.5	10
R825-8	40	8 M.A.	22.5	17
R825-10	40	10 M.A.	22.5	17

PIEDINO REGOLABILE PIATTO IN TERMOPLASTICO

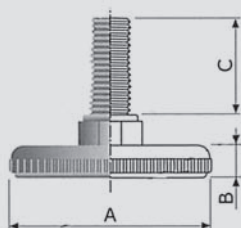

con dado in plastica a partire dal Ø 40 (fornito anche senza dado)

CODICE	A	PERNO	B	C
R948	Ø 40	8-10 M	8	25
R947	Ø 50	8-10 M	8	25-32
R946	Ø 60	8-10 M	8	25-32

PIEDINO A VENTOSA IN PVC

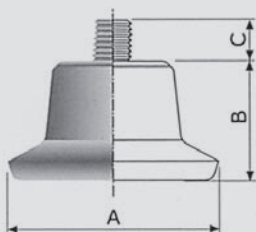

CODICE	A	PERNO	B	C
R930	Ø 40	8 M	21	8

PIEDINO IN FERRO-ZINCATO O IN ACCIAIO INOX

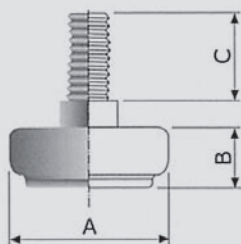

con dado e base in plastica

CODICE	A	PERNO	B	C
R990	Ø 35	10 M	14	20
R991	Ø 35	8 M	14	20

CON BASE BOMBATA RICOPERTA ACCIAIO

Ottonati - Cromati

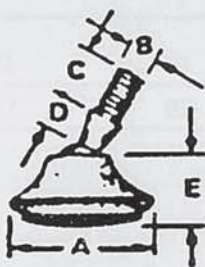

CODICE	A	B	C	D	E
R720	Ø 25	Ø 8	10	6	13

PIEDI SNODATI CON ESAGONO 10

Ottonati - Cromati

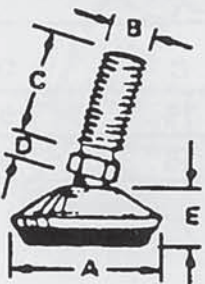

CODICE	A	B	C	D	E
R750	Ø 35	Ø 10	10	5	12
R751	Ø 35	Ø 10	20	5	12
R752	Ø 35	Ø 10	30	5	12
R753	Ø 50	Ø 10	10	5	16
R754	Ø 50	Ø 10	20	5	16
R755	Ø 50	Ø 10	30	5	16

CON BASE PIANA IN NYLON NERO

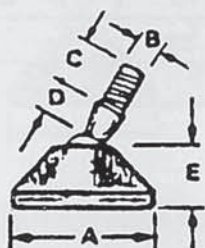

CODICE	A	B	C	D	E
R759	Ø 26	Ø 8	10	6	

BASE IN NYLON NERO GAMBO CON ESAGONO 10

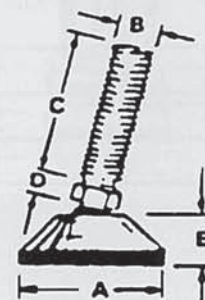

CODICE	A	B	C	D	E
R757	Ø 26	Ø 10	20	5	11,5
R758	Ø 26	Ø 10	30	5	11,5

VOLANTINI

VOLANTINO CON GAMBO FILETTATO IN POLISTIROLO ANTIURTO

a 6 lobi

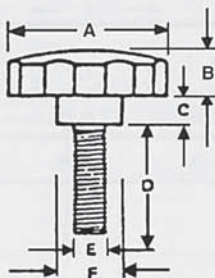

CODICE	A	B	C	D	E	F
S017	Ø 30	10	8	10	Ø 6	13,5
S016	Ø 30	10	8	15	Ø 6	13,5
S018	Ø 30	10	8	20	Ø 6	13,5
S014	Ø 30	10	8	20	Ø 8	13,5

VOLANTINO CON GAMBO FILETTATO IN POLISTIROLO ANTIURTO

a 8 lobi in polistirolo antiurto

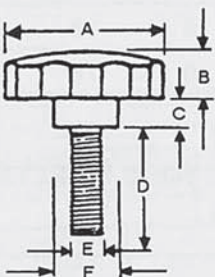

CODICE	A	B	C	D	E	F
S010	Ø 40	11	7,0	20	Ø 8	16
S011	Ø 40	11	7,0	20	Ø 10	16
S012	Ø 50	14	8,5	20	Ø 10	18
S015	Ø 50	14	8,5	25	Ø 10	18
S013	Ø 50	14	8,5	30	Ø 10	18

VOLANTINO CON GAMBO FILETTATO IN NYLON

Rotondo zigrinato

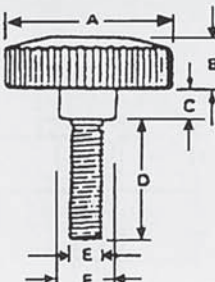

CODICE	A	B	C	D	E	F
S160	Ø 50	16	8	20	Ø 10	Ø 18
S161	Ø 50	16	8	25	Ø 10	Ø 18
S162	Ø 50	16	8	30	Ø 10	Ø 18

VOLANTINI CIECHI IN POLISTIROLO ANTIURTO CON BUSSOLA OTTONE FILETTATA

Modello a 6 lobi

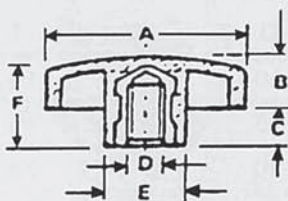

CODICE	A	B	C	D	E	F
S056	Ø 30	10	8	Ø 6	13,5	14
S057	Ø 30	10	8	Ø 8	13,5	14

Modello a 8 lobi

CODICE	A	B	C	D	E	F
S050	Ø 40	11	6,5	Ø 6	16	14
S051	Ø 40	11	6,5	Ø 8	16	14
S053	Ø 40	11	15,0	Ø 8	16	20
S054	Ø 50	14	9,5	Ø 8	18	18
S055	Ø 50	14	9,5	Ø 10	18	16

VOLANTINO IN NYLON CON BUSSOLA IN OTTONE FILETTATA

Rotondo zigrinato

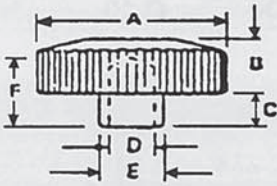

CODICE	A	B	C	D	E	F
S170	Ø 50	14	9,5	Ø 8	18	18
S171	Ø 50	14	9,5	Ø 10	18	16

MANOPOLE

MANOPOLE A GALLETTO IN NYLON CON PERNO FERRO ZINCOCROMATO

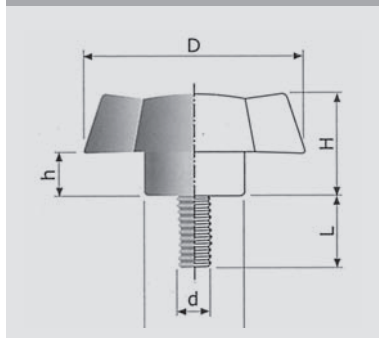

CODICE	D	d	L	H	h	d1
S109	28	4 MA	10	13	5	12
S105	28	5 MA	10	13	5	12
S106	28	5 MA	15	13	5	12
S110	28	6 MA	10	13	5	12
S107	28	6 MA	12	13	5	12
S108	28	6 MA	12	13	5	12

MANOPOLE A GALLETTO IN NYLON CON BOCCOLA OTTONE

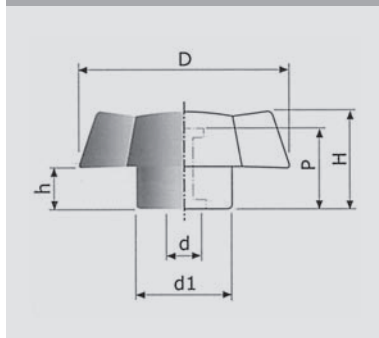

CODICE	D	d	P	H	h	d1
S120	40	4 MA	14	20	11	12
S122	40	5 MA	14	20	11	12
S123	40	6 MA	15	20	11	12

MANOPOLE ZIGGRINATE IN NYLON CON PERNO FERRO ZINCOCROMATO

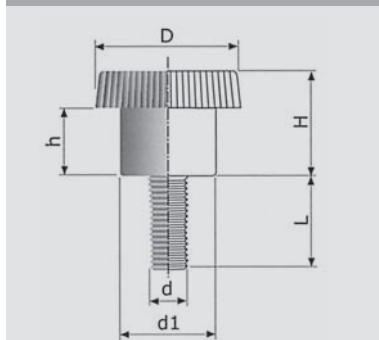

CODICE	Ø D x d	L	H	h	d1
S130	14 x 4 MA	10	10	6	9
S131	14 x 4 MA	12	10	6	9
S132	14 x 5 MA	10	10	6	9
S133	14 x 5 MA	12	10	6	9

MANOPOLE ZIGGRINATE IN NYLON FILETTATE FEMMINA

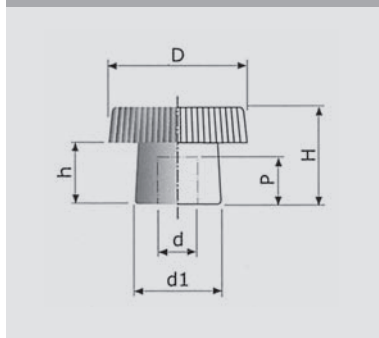

CODICE	Ø D x d	L	H	h	d1
S135	14 x 4 MA	6	10	6	9
S136	14 x 5 MA	6	10	6	9

PARACOLPI TESTA ROTONDA



Duri - Elastici

CODICE	Ø TESTA	Ø GAMBO	A	B
G500	9	5	6	3,0
G501	14	9	6	4,5
G502	14	6	15	6,5
G503	20	10	10	8,0

PARACOLPI TESTA BOMBATA

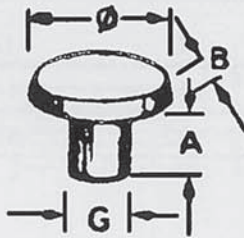

Duri - Elastici

CODICE	Ø TESTA	Ø GAMBO	A	B
G550	9,5	5	6,0	3
G551	12	6	7,5	3
G552	14	6	15	4
G553	18	8	15	5
G554	20	8	15	5
G555	24	11	13	5
G556	24	11	7	

PARACOLPI TESTA PIATTA



Duri - Elastici

CODICE	Ø TESTA	Ø GAMBO	A	B
G600	12	6,0	9	2,5
G602	12	6,0	9	3,8
G601	7	3,5	5	1,5
G603	6,5	3,5	5	1,5

Testa piatta trasparente

CODICE	Ø TESTA	Ø GAMBO	A	B
G602	12	6,0	9	3,8

PARACOLPI

RONDELLE PARACOLPO IN PVC

Nere - Bianche (Colorate a richiesta)

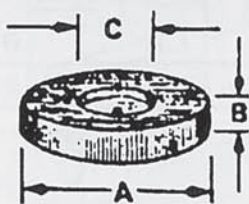

CODICE	A	B	C
G270	25	6	10,0
G271	22	6	10,0
G272	18	6	9,5
G273	15	5	8,5
G274	10	6	5,0

PARACOLPI QUADRI NERI IN PVC

Morbidi - Normali

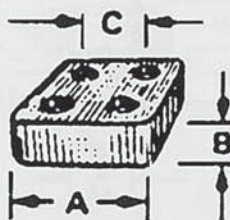

CODICE	A	B	C
G300	22 x 22	8	11

PARACOLPI CON CHIEDO IN PVC

Neri - Bianchi (Colorati a richiesta)

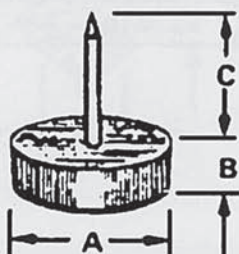

CODICE	A	B	C
G320	25	9	19
G321	20	6	15
G322	15	12	15
G323	15	7	15

PARACOLPI CON CHIEDO E PATTINO CROMATO

Neri - Bianchi (Colorati a richiesta)

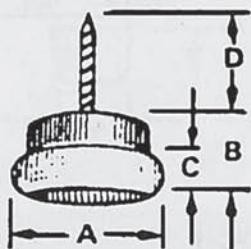

CODICE	A	B	C	D
R111	15	10	6	17
R115	20	11	6	17
R119	25	12	7	17
R123	40	13	7	17

PARACOLPI TESTA BASSA

Duri - Elastici

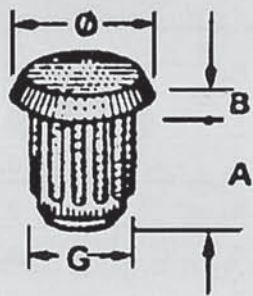

CODICE	Ø TESTA	Ø GAMBO	A	B
G620	12,5	8	9	2

PARACOLPI TESTA RETTANGOLARE

Duri - Elastici

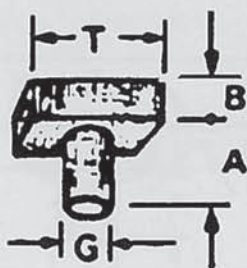

CODICE	Ø TESTA	Ø GAMBO	A	B
G640	15 x 10	6	9	4,5
G641	15 x 10	6	9	10,0

PARACOLPO ROTONDO

Elastici

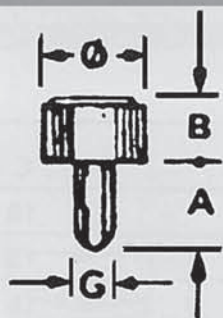

CODICE	Ø TESTA	Ø GAMBO	A	B
G650	11	4,2	10	7

PARACOLPO A TRONCO DI CONO

Duri



CODICE	Ø TESTA	Ø GAMBO	A	B
G655	12 - 26	6	12	11

PARACOLPI CON GAMBO IN POLITENE BIANCHI

Duri

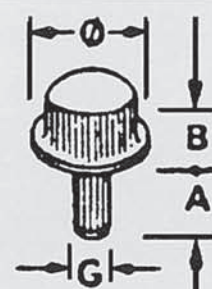

CODICE	Ø TESTA	Ø GAMBO	A	B
G750	17,0	5	8,5	6,5
G751	23,5	5	11,5	10,5

PARACOLPI

PARACOLPI CON 2 GAMBI IN POLITENE BIANCHI

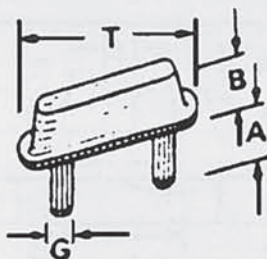

Duri

CODICE	Ø TESTA	Ø GAMBO	A	B
G753	43 x 15,5	5	8	12

PARACOLPI TESTA BOMBATA

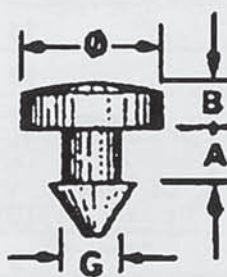

Elastici

CODICE	Ø TESTA	Ø GAMBO	A	B
G700	12	5	4,5	4

PARACOLPI TESTA ROTONDA



Elastici

CODICE	Ø TESTA	Ø GAMBO	A	B
G720	8	6	1	1,5

PARACOLPI TESTA BOMBATA

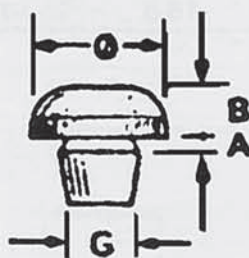

Elastici

CODICE	Ø TESTA	Ø GAMBO	A	B
G740	12	6	1	2
G741	12	6	1	4,5

PARACOLPI CON PIOLINI

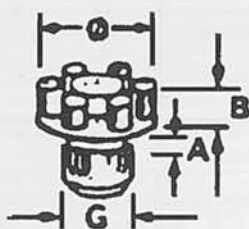

Elastici

CODICE	Ø TESTA	Ø GAMBO	A	B
G745	12	7	1	4
G746	12	7	1	6

TUBETTO DISTANZIATORE

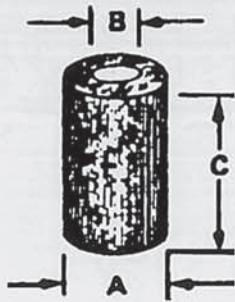

Neri - Bianchi (Colorati a richiesta)

CODICE	A	B	C
G010	8	5	3,7
G011	10	4	20
G012	10	6	4
G013	10	6	6
G014	10	6	9
G015	10	6	10
G016	10	6	12
G017	10	6	14
G018	10	6	15
G019	10	6	17
G020	10	6	19
G021	11	4	10
G022	11,5	7,5	5
G023	12	8,5	6
G024	13	6,3	3,5
G025	14	5	3
G026	14	5	9
G027	14	6,5	7
G028	17	6	10

TUBETTO PARACOLPI OCCHI TONDI

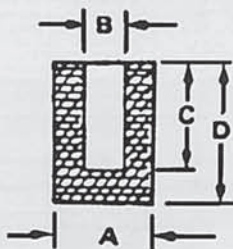

Neri - Bianchi (Colorati a richiesta)

CODICE	A	B	C	D
G050	17	12	21	24
G051	14	6	16,5	18

TUBETTI DISTANZIATORI CON INCAVO

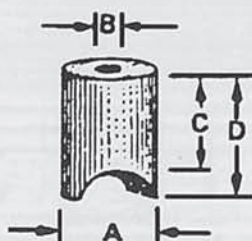

Neri - Bianchi (Colorati a richiesta)

CODICE	A	B	C	D
G100	13	5,5	5	9,5
G101	13	5,5	7	11,5
G102	13	5,5	14	18
G103	17	6	5	9
G104	17	6	7	11,5
G105	17	6	10	14,5
G106	17	6	14	18,5
G107	17	6	16	21

PARACOLPI

PARACOLPI CON CHiodo TESTA ROTONDA IN PVC

Bianchi - Elastici

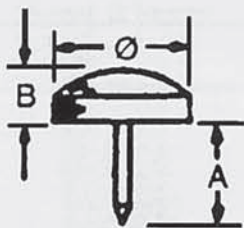

CODICE	Ø TESTA	A	B
G470	9,5	11	3,5
G471	17,5	12	3,5

PARACOLPI CON 2 CHIODI BIANCHI IN PVC

Duri

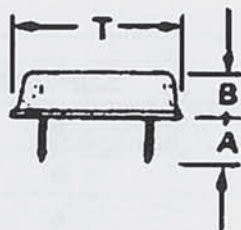

CODICE	Ø TESTA	A	B
G490	46 x 16	10	14

DISTANZIATORE CONICO ZIGRINATO

Bianchi (Colorati a richiesta)

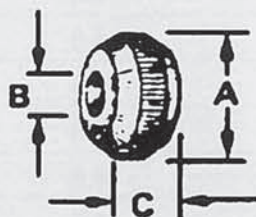

CODICE	A	B	C
G130	14	5	9

DISTANZIATORE BOMBATO ZIGRINATO

Neri - Bianchi (Colorati a richiesta)

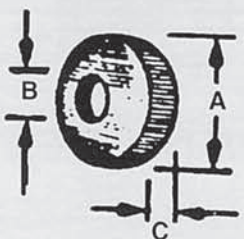

CODICE	A	B	C
G131	20	5	8

DISTANZIATORE LISCIO

Neri - Bianchi (Colorati a richiesta)

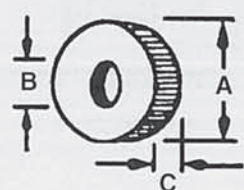

CODICE	A	B	C
G132	20	6,5	7

PARACOLPI TRANCOCONICI IN PVC

Neri - Bianchi (Colorati a richiesta)

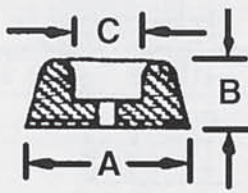

CODICE	A	B	C
G150	29	12	13,5
G151	24	10	9,5
G152	21	11	9
G153	19	10	9
G154	19	13	8
G155	18,5	18	8
G156	18	8	7
G157	13	6	6

PARACOLPI CON INCAVO IN PVC

Neri

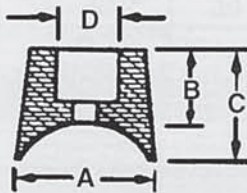

CODICE	A	B	C	D
G200	20	9	14	9
G201	22	11	18	10

PARACOLPI CON INCAVO CILINDRICI IN PVC

Neri

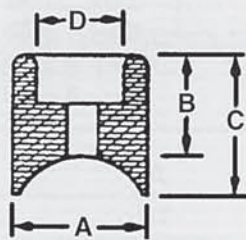

CODICE	A	B	C	D
G220	25	20	28	15

FERMA BATTUTE PORTE IN PVC

Neri

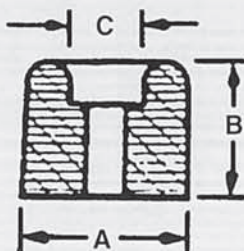

CODICE	A	B	C
G250	20	23	9
G251	25	24	11
G252	30	25	13

PARACOLPI

SOTTOPIEDE A PINZA LUNGO IN POLITENE

Neri - Bianchi (Colorati a richiesta)

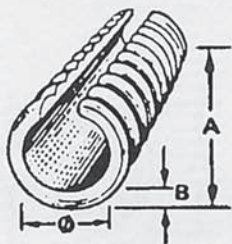

CODICE	MISURA	Ø POLO	A	B
E250	18 - 20	6	46	4,5
E251	20 - 22	-	-	-
E252	24 - 26	8	46	5,0
E253	28 - 30	8	46	5,5

SOTTOPIEDE A PINZA IN POLITENE

Neri - Bianchi (Colorati a richiesta)

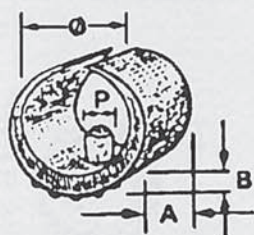

CODICE	MISURA	Ø POLO	A	B
E300	14 - 16	5,5	18	3,5
E301	16 - 18	5,5	19	3,5
E302	18 - 20	5,5	20	3,5
E303	20 - 22	5,5	22	4,0
E304	24 - 26	5,5	25	5,0
E306	24 - 26	7,5	7,5	5,0
E299	12	-	-	-
E305	28 - 30	7,5	30	5,5

DISTANZIATORI A PINZA IN POLITENE

Neri - Bianchi - Colorati

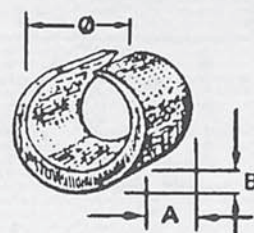

CODICE	MISURA	A	B
E310	18 - 20	18	3,0
E311	24 - 26	18	3,5

PASSAFILI IN PVC

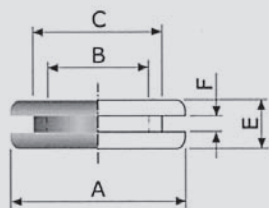

N°	A	B	C	E	F
1	10	3,5	9	6	1
2	10	4	8	6	1,5
3	9	5	7	6	1
4	12	5	8	5	1/1,5
5	11	5	9	8	1
6	15	5	10	5,5	1
7	13	5	11	7	1,5
10	14	7,5	10	8	1,5
11	15	6,5	10	6	1,5/4
12	17	9	13	5	2
13	18	11	15	6	2
14	16	9,5	12	10	1/2,5
15	19	10	15	7,5	1,5
18	14	6,5	10	7,5	1,5
19	22	12	18	10	3
22	33	19	25	10	1,5
23	26	12	19	7	1
24	13	6	10	5	1/2,0
25	13	7	10	6	1,5
26	28	16	20	8	2
27	23	14	19	6	1,5
28	12	6	8	5	1,5/4
29	33	18	25	7	1,5
30	25	14	17	7	1
31	25	10	17	7	2
32	21	12	16	7	1,5
33	18	8	12	10	3
CON MEMBRANA FORO ADATTABILE					
8	15	6/9	12	6	1,5
9	16	5/8	13	5	1,5
16	18	5/9	14	7,5	1,5
20	26	5/15	20	7,5	1
21	23	7/14	19	5,5	2

ACCESSORI

VENTOSE CON GAMBO FORATO IN PVC

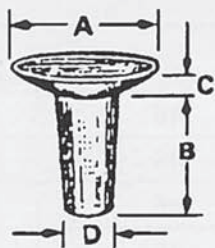

CODICE	Ø A	B	C	Ø D
M010	15	10	4	6
M011	20	8,5	6,5	6

VENTOSA CON SFERA IN PVC

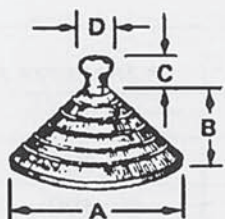

CODICE	Ø A	B	C	Ø D
M020	20	10	4	6
M021	25	12	5	7
M022	30	13	5	8

FERMACRISTALLI CON VITE IN POLICARBONATO

Neri - Cromati - Ottonati

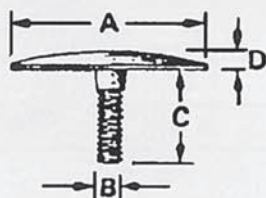

CODICE	Ø A	Ø B	C	D
R091	35	8	45	5
R090	50	8	45	5
R089	60	8	45	5
R088	80	8	45	5

PROFILATO ROTONDO



CODICE	Ø MISURA	PESO AL MT CIRCA
N150	10	GR. 75
N151	14	GR. 90
N152	16	GR. 120
N153	18	GR. 130
N154	20	GR. 145
N155	22	GR. 150
N156	25	GR. 155
N157	28	GR. 210
N158	30	GR. 220

PROFILATO QUADRO E RETTANGOLARE

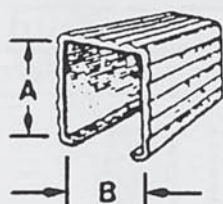

CODICE	A	B	PESO AL MT. CIRCA
N180	20	20	GR. 200
N181	25	25	GR. 280
N182	30	30	GR. 360
N183	40	20	GR. 285
N184	50	25	GR. 460
N185	60	25	GR. 520

VENTOSA IN PVC CON GAMBO FILETTATO IN NYLON

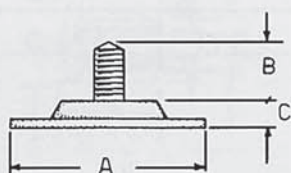

CODICE	A	B	C	D	E
S102	44	24	10	Ø 6	20
S100	44	25	15	Ø 6	20
S101	44	25	20	Ø 8	20

INNESTI PER TUBI IN TECNOPOLIMERO

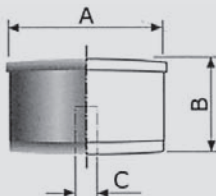

CODICE	Ø A	B	C	S.T.
Z006	35	30	8 M	1
Z025	50	33	8 M	1
Z028	60	33	10 M	2

PUNTALI PER ANGOLARI IN POLITENE

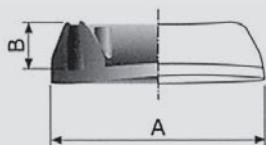

CODICE	MISURA	A	B
C011	35 x 35	55	10
C151	20 x 40 x 2	a "L" destro /sinistro	
C152	70 x 55 x 2	a "T"	
C153	45 x 30 x 45 x 2	a "U"	

SOTTOTAPPI IN POLITENE



Disponibili in misura da Ø 2 mm. a Ø 200 mm.

ACCESSORI

MANOPOLA PER CARRELLI IN PVC

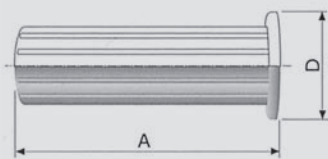

CODICE	D	H
S124	20	110
S123	22	110
S125	25	110
S126	27	110
S127	30	110

BOCCOLE VARIE MISURE

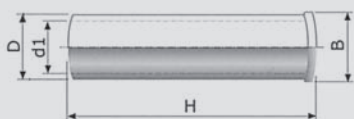

CODICE	d1	D	H	B
N600	25	29	105,5	32
N601	26	29	105,5	32
N602	28	32	120	36

CALOTTA COPRICROCIERA IN ABS

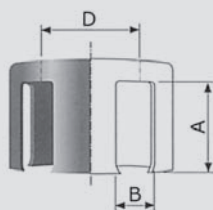

nera - metallizzata argento

CODICE	D	A	B	LAME
F483	51	40	20	2
F484	51	40	20	4
F482	51	40	20	5

ROTELLA IN NYLON O POLIPROPILENE



CODICE	Ø	FORO	B
Z300	40	6	23
Z301	40	8	23
Z302	50	6	20
Z303	50	8	20

PUNTALE ESTERNO OVALE IN PVC

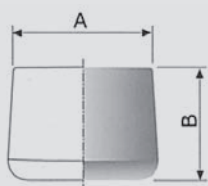

neri - bianchi (colorati a richiesta) misure riferite all'esterno del tubo

CODICE	A	B
B641	30	15
B640	36	18
B642	40	20

PINZA A 2 PIOLI IN POLITENE

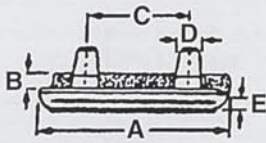

CODICE	A	B	C	D	E
V260	33	13,5	18	4,5	2,5

RONDELLE SOTTOVITI IN POLITENE HD

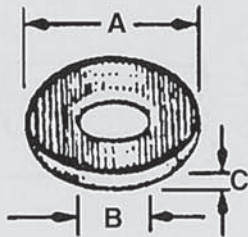

Misure riferite al \varnothing esterno

CODICE	\varnothing A	\varnothing B	C
V220	11	5,5	1,5
V221	11,5	3,2	1,2
V222	12	4,5	1,5
V223	14	6	1,5
V224	15	5	1,5
V225	16	6	1,5
V226	22	10	2,0
V227	24	8,5	2,0

INNESTI PER TUBO QUADRO 20 x 20 IN ABS

MODELLO 3 VIE

Nero - Cromato - Ottonato

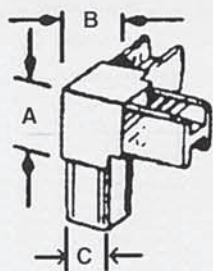

CODICE	A	B
Z018	25	25

MODELLO 4 VIE

Nero - Cromato - Ottonato

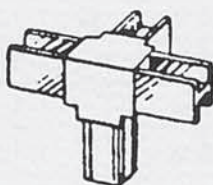

CODICE	A	B
Z019	25	25

MODELLO 5 VIE

Nero - Cromato - Ottonato

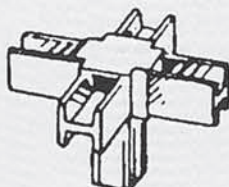

CODICE	A	B
Z020	25	25

MODELLO 6 VIE

Nero - Cromato - Ottonato

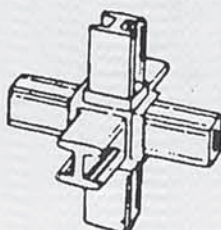

CODICE	A	B
Z021	25	25

INNESTI PER TUBO QUADRO 20 x 20 IN ABS

MODELLO A L

Nero - Cromato - Ottonato

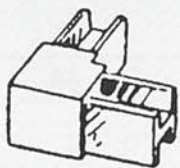

CODICE	A	B
Z017	25	25

MODELLO A T

Nero - Cromato - Ottonato

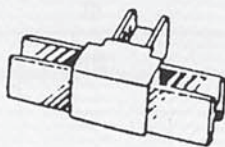

CODICE	A	B
Z023	25	25

MODELLO A CROCE

Nero - Cromato - Ottonato

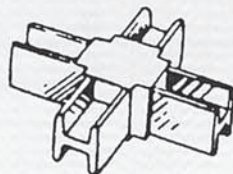

CODICE	A	B
Z022	25	25

INNESTI PER TUBO QUADRO 25 x 25 IN ABS

MODELLO 3 VIE

Nero - Cromato - Ottonato

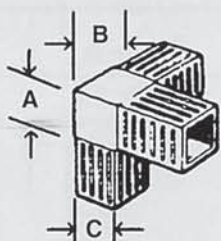

CODICE	A	B
Z015	30	30

MODELLO 4 VIE

Nero - Cromato - Ottonato

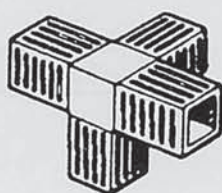

CODICE	A	B
Z016	30	30

MODELLO 5 VIE

Nero - Cromato - Ottonato

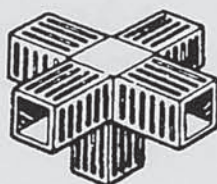

CODICE	A	B
Z009	30	30

MODELLO A L

Nero - Cromato - Ottonato

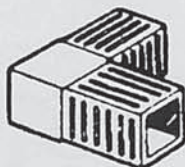

CODICE	A	B
Z010	30	30

- I • Una vastissima gamma di articoli in plastica per la vostra produzione.
- Stampaggio particolari in tecnopolimeri.
- Progettazione e costruzione stampi su disegno.

- GB • A large range of plastic articles for your production.
- Item forming in technopolymer.
- Mould form planning and manufacturing to drawing.

- D • Eine breite reihe von kunststoff artikeln für ihre produktion.
- Teilen-pressen aus tecnopolymer.
- Gesenk planung und entwicklung nach zeichnung.

L.U.PLAST

ACCESSORI IN PLASTICA

Via degli Aceri Rossi, 19
20050 Veduggio con Colzano (MB)
Fax 0362.998042 - e-mail: luplast@tiscali.it
Magazzino: Via Cascina Nuova, 2b
23893 Cassago B.za (LC) - Tel. 039.9211913